

Furness Railway Wagon Co.

GER/LNER/BR/RCH 7/9ton Gunpowder/Explosives Van

Wheels, paint and transfers required to complete.

Please note that to aid the folding of the various parts score all the halfetched foldlines that are to be folded.

The Parts.

Part 1

Part 3

Part 11

Part 2

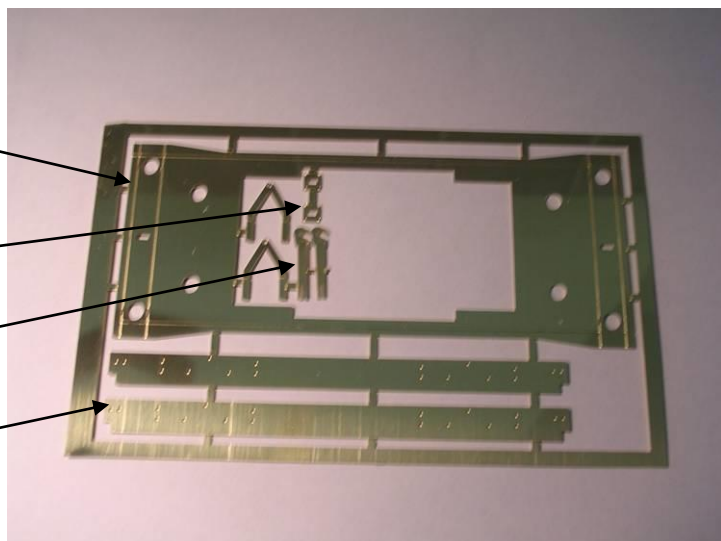

Part 10

Part 16

Part 15

Parts 17/18

Part 12/13

Part 7

Part 8

Part 14

Part 9

Part 11

Part 6

Part 4

Part 5

Part 19

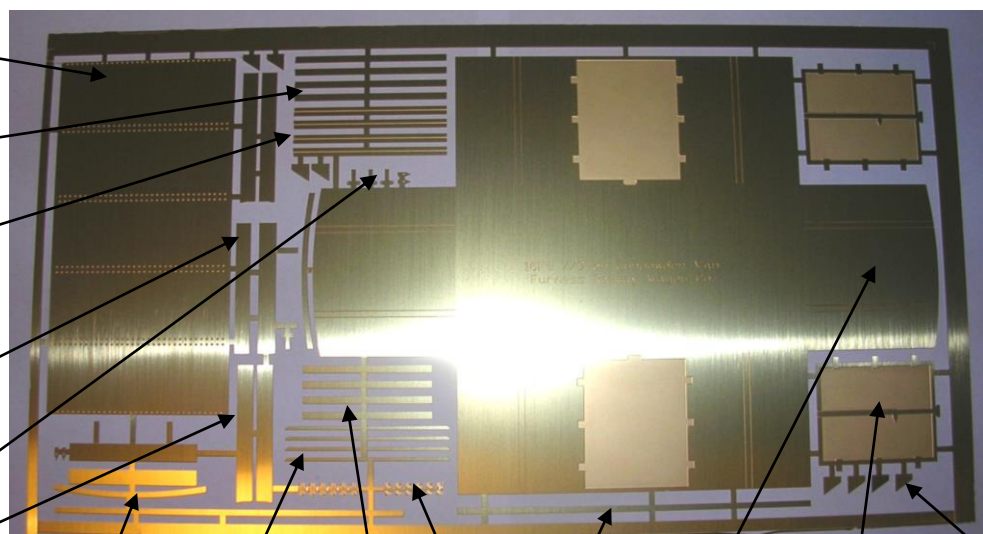

Chassis Construction.

1. Remove chassis (part 1) from the etch and fold up the bottom of the buffer beam between parallels as show

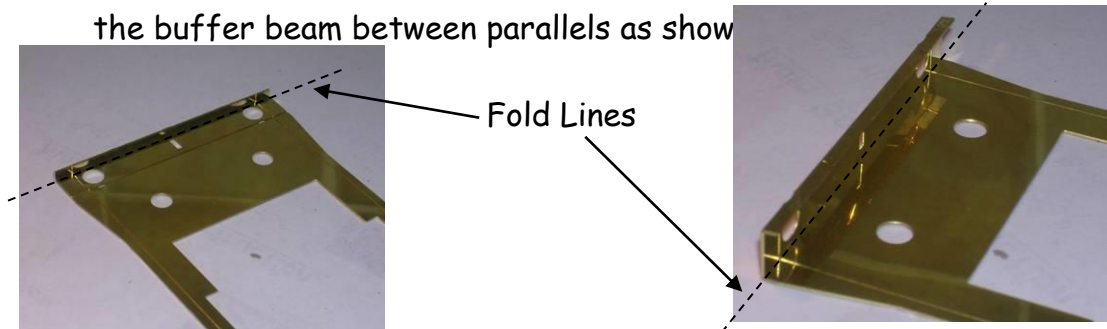

2. Next fold up the buffer beam completely as shown. Make sure that the resulting U shape is square so as to fit the sole bars. Repeat for the other end of the chassis.
3. Remove the sole-bars (part 2) and punch out the rivets. Next fold up the bottom of the sole-bars between two parallels. Make sure that the resulting shape is square.

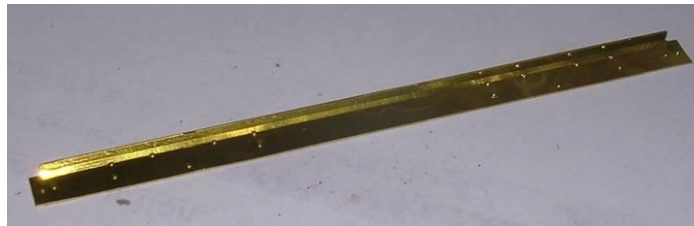

4. Click one of the sole-bars in to the half etch slot that runs between the two buffer beams. Solder into position using 188C solder. Make sure that the sole-bars are actually soldered inside the buffer beam. Repeat for the other sole-bar.

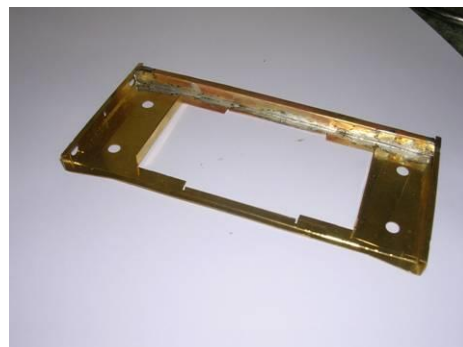

- Next remove the buffer beam reinforcing plates (part 3) and punch out the half etched rivets and tin the back of each piece with 188C solder. Now sweat the plates onto the half etched square in the front of the buffer beam.

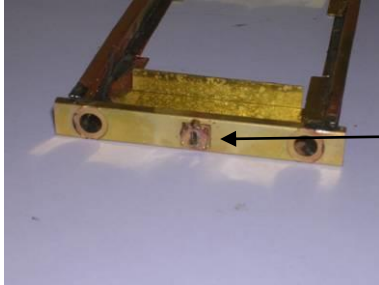

Buffer beam reinforcing plates

Final Assembly of van.

Van Body Construction.

- First remove the Part 4 (the body) from the etch then punch out the half etch rivets.
- Next remove part 5 (the door) and punch out the half etch rivets. This is then soldered into the half etched recess as shown.
- Next remove parts 6 (Long edging strips) from the etch, and punch out the rivets. Solder the edging strips onto the body. Make sure that the strips are parallel to the body.
- Once all the parts are soldered to the body, fold up it up and solder the corners. It is also a good idea to run a solder fillet down the inside of the body

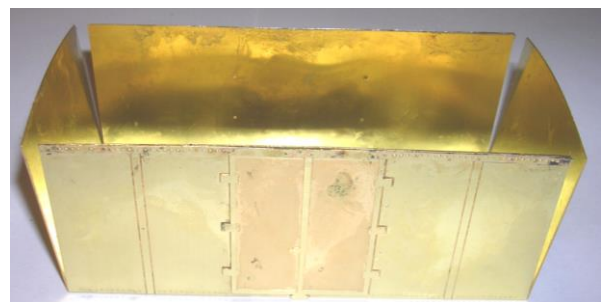
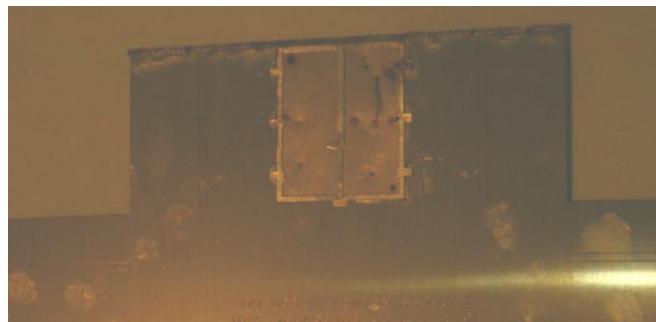

where the floor meets the sides and ends for extra strength as shown.

5. Next remove parts 7 (corner plates) and punch out the half etched rivets. Then fold along the half etched lines so the faces are at right angles. Note these pieces are handed and

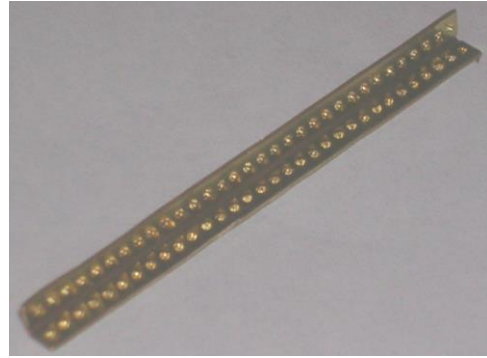

have a slight taper on one side to fit under the roof line. These are now requiring to be soldered onto the corners as shown.

6. Next take parts 8 (curved edging strips) from the etch. Punch out the rivets. Solder the edging strips onto the body. Make sure that the strips are parallel to the curve of the body and the corner plates.

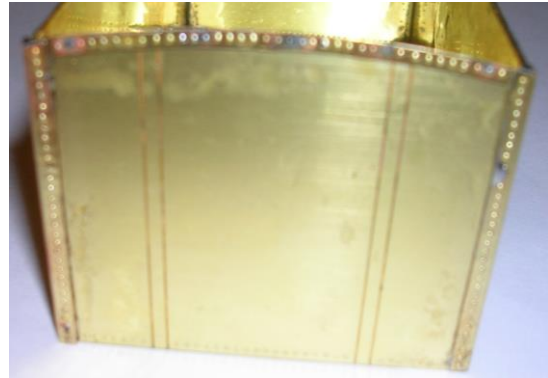

7. Take parts 9 (side bracing) and solder them onto the sides of the van using the half etched lines as a guide.

8. Next take part 10 (roof) and punch out the half etch rivets in the raised banding. This rivet punching should roll the roof to its correct shape. However it may



require to be rolled a little more to achieve the correct shape.

Solder the roof onto the van body, being careful not to disturb the edge strips.

9. Attach parts 11 (door hinges) and part 12/13 (door latches) to the pads on the door as shown.

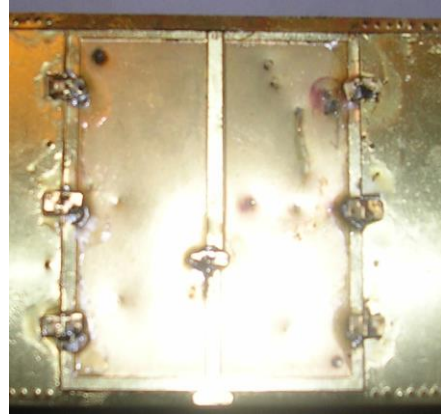

10. Solder the van top to the chassis as shown.

11. Now you need to decide which end supports to use. If you are building the GER/LNER vans they had 'T' section end supports. Privately owned van's varied depending on the builder so could be flat bar or 'T' section.

12. To build the 'T' sections take parts 14 and 15 and punch out the half etched rivets and solder together as shown. If building a van with the flat bar end supports take parts 16 and punch out the half etched rivets.





13. Solder the end supports of your choice into position as shown.

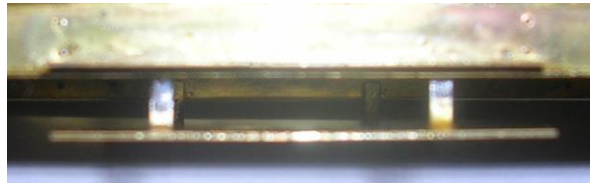

14. Take parts 17 (top step) and solder to the top of the bottom lip of the sole-bar. Next take parts 18 (bottom step) and fold up and solder into position underneath the top step. As shown.

15. Finally take parts 19 (body support angles) punch out the rivets and fold away from the half etched lines.

Final Construction

1. Next, assemble the links (part 17) on to the coupling hook (part 18) and push through the slot. Now push the spring (part 19) over the back of the back of the coupling hook and bend the tags over to secure the spring in place. Then fix the four buffers (part 20) into the holes in the buffer beam using two part epoxy.

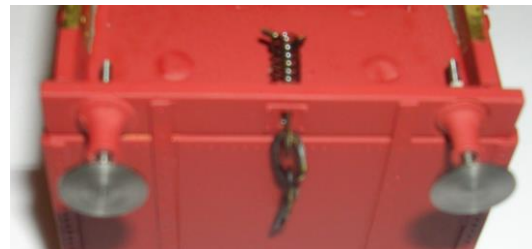

2. Drill out the w-iron castings to suit the bearings of your chosen wheels. Assemble a wheel set, 2 x W-iron's (part 21), 2 x bearing's and 1 x wheel/axle unit, do not glue the bearings into the W-irons. Again using two part epoxy resin, glue the assembled wheel set onto the sole-bars so that they

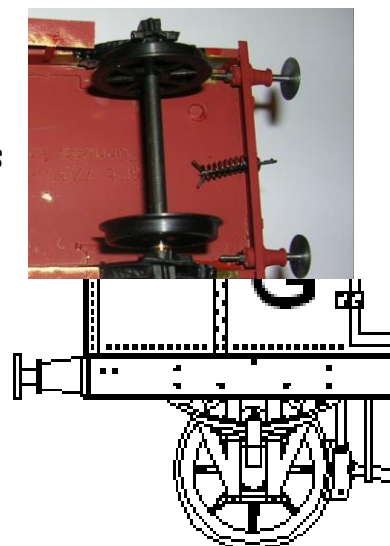

are square and line up with the rivets as shown in the drawing.

3. Repeat for the other wheel set. Use a straight edge across the back of the wheels to aid getting these parallel and square to the chassis.



4. Place the brake gear casting (part 22) against the inside of sole-bar and slide down into the chassis with the spigot pointing outward. You may require to chamfer the casting so that it clears the solder fillet between the chassis and the sole-bar. Glue the casting into position using two part epoxy resin, this will give you opportunity for adjustment. Position the casting with care centrally between the rivets on the sole-bar.

5. Next fix the brake lever and ratchet casting (part 23) to the sole-bar and to the V-hanger as shown below.



6. Paint the model in the livery of your choice.



History of the Wagon

Great Eastern Railway.

Between 1898 and 1905, the Great Eastern Railway ordered ten 7 ton gunpowder vans from the company's own Temple Mills wagon works. The vans were of an all steel construction lined with match wood, with lead on the floor. The vans had a double cupboard access door fitted on each side. The vans were fitted with oil axel boxes and brakes on one side only. The wagons were used to convey gunpowder and explosives around the system but would have been seen all over the country going to and from the various gunpowder mills. The Great Eastern railway numbered the vans 21967-72 and 21977-80. All the vans of this batch were absorbed into the LNER. These would have been renumbered by adding 600,000. Two of these vans managed to last into early British Railways.

In Great Eastern Railway days the vans would have been painted black below the sole-bars, chocolate brown to the middle of the van with the top being painted bright red. The roof being painted white. Vans would have been painted Vermilion by the LNER. In British Railways days, the vans would have been painted a similar shade to that of the LNER.

Privately Owned wagons

Vans of this type were built by a number of wagon works around the country for various explosives factories and gunpowder mills. Hurst Nelson and Metropolitan Wagon and Carriage, being two examples. These vans would have been turned out in various liveries to suit their owners. Known liveries are W.H. Wakefield's at Milnthorpe (LNWR) and at Haverthwaite (FR), and Elterwater Gunpowder Co. near Windermere (LNWR).

Liveries

Great Eastern Railway Livery Circ 1903

Numbers painted on black panel in the top left hand side and on a cast plate in the bottom left hand side.

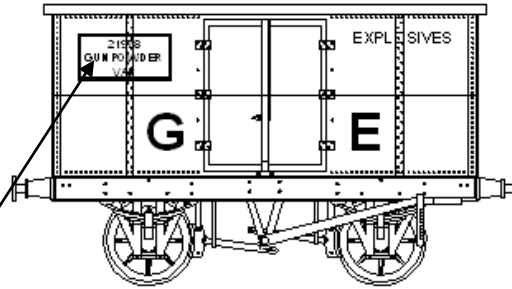

Numbers

Great Eastern Railway Livery Circ 1913

Numbers painted on black panel in the bottom right hand side and on a cast plate in the bottom left hand side.

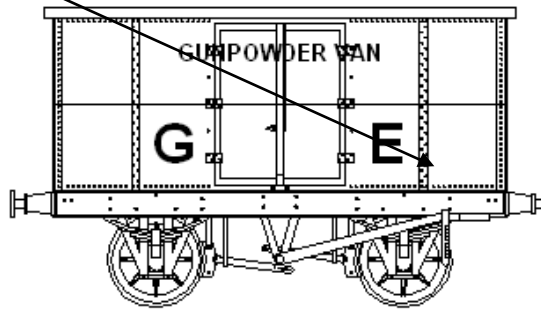

LNER early Livery Circ 1923-

Numbers

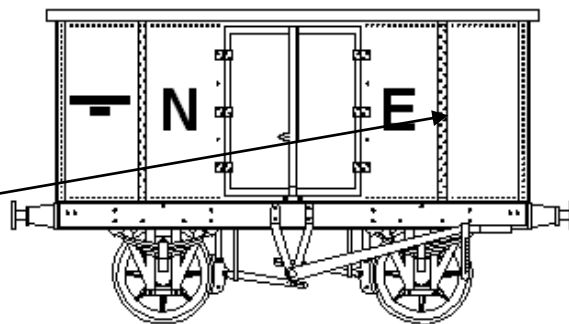

LNER Late Livery Circ 1936-47

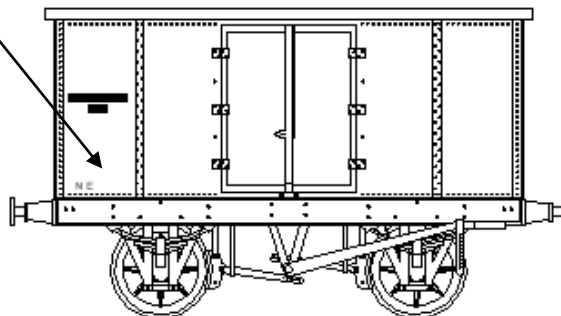

Furness Railway Wagon Co.

GER/LNER/BR/RCH 7/9ton Gunpowder/Explosives Van

1. Construction Manual,
2. One Brass chassis etch,
3. One Brass body etch.
4. One brake gear castings,
5. One brake lever castings,
6. Four W-iron/axle box castings,
7. Four buffer assemblies,
8. Two coupling hook springs,
9. Six coupling hook links.

We recommend Haywood Railway's 3'1" split spoke wheels.

Various transfers are available from POWSIDES.